

# Week 6 & 7

# 3<sup>rd</sup> Grade

# Independent Study Packet

 Education.com

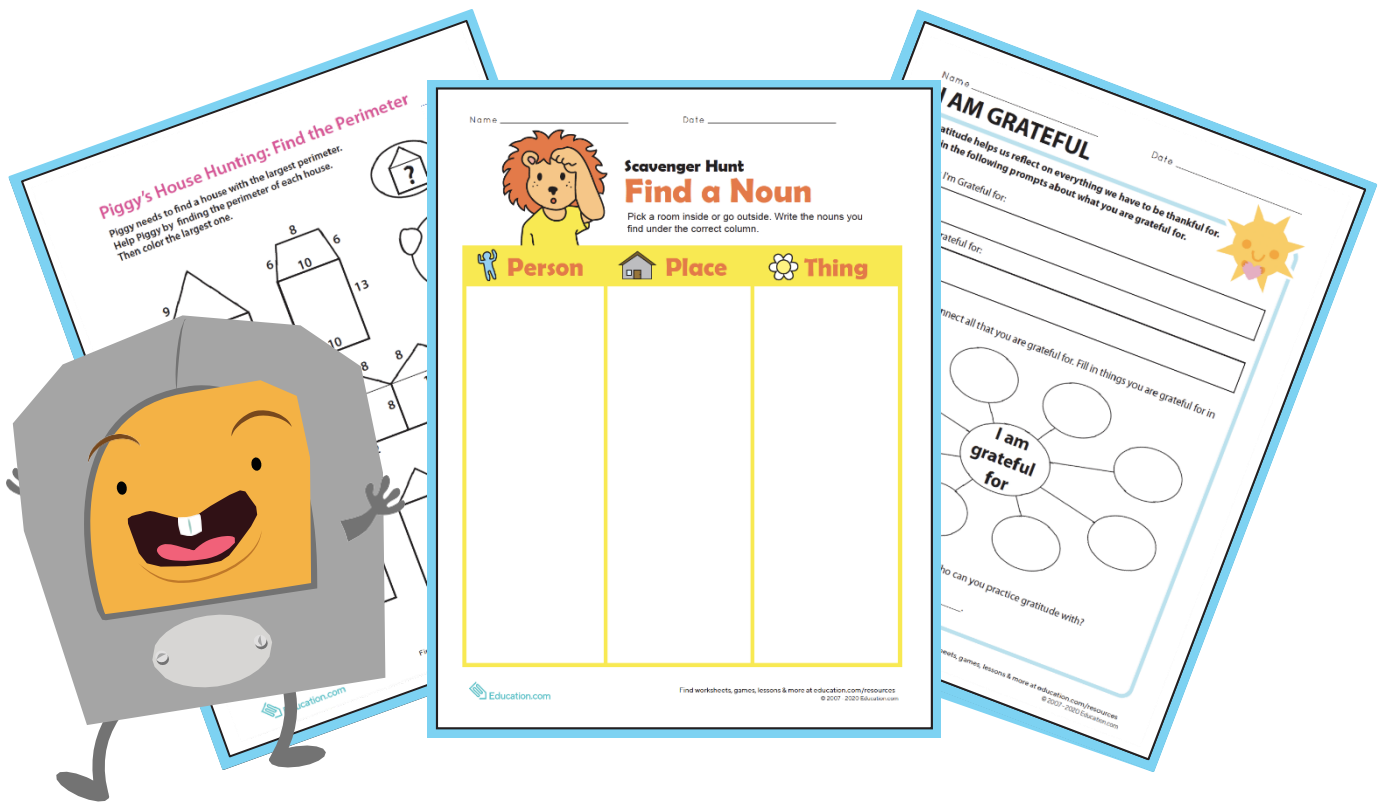

**5 MORE Days of  
Independent Activities in  
Reading, Writing,  
Math, Science, and Social Studies**

# Helpful Hints for Students and Families

## Materials You Will Need:

- Pencils
- Extra paper or a notebook/journal (You may put everything into one notebook if you like.)
- Colored pencils, markers, or crayons for some of the activities
- You will need extra “found” supplies for the optional Design Challenges
- Dice



## Directions & Tips

- There is a schedule for each day.
- You may complete the activities in any order.
- Read the directions carefully before completing each activity.
- Make sure to plan your time so that you don't let things pile up at the end.



# MINDFUL MOVEMENT

Walk like a deer to become more aware of how you move.

**Sometimes when we want to be mindful we are still.  
We can also be mindful when we move.**

Practice walking like a deer. Move slowly and deliberately, with purpose, and pay attention to where you are walking. Practice pausing in stillness, as though you are camouflaged.

**Write your response.**

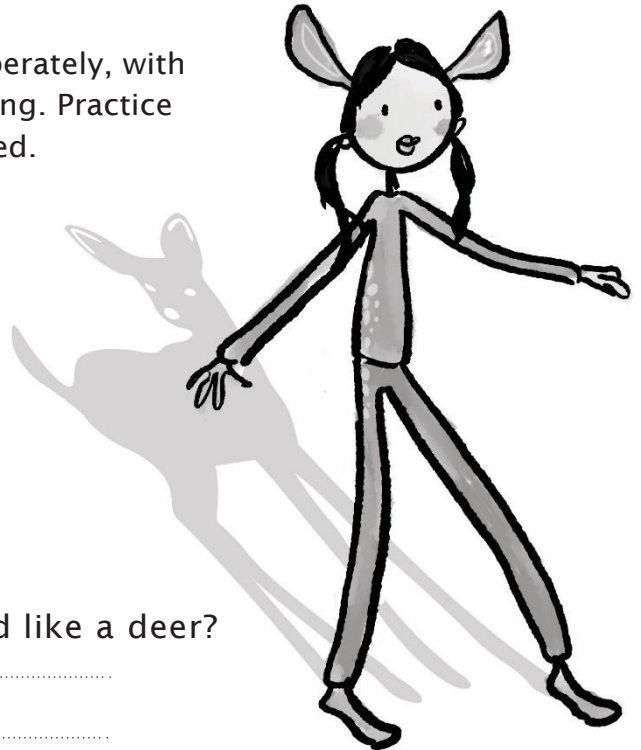

1. What does it feel like to walk like a deer?

.....  
.....  
.....  
.....

2. What does it feel like to be still/camouflaged like a deer?

.....  
.....  
.....  
.....

3. Describe a time when you can walk mindfully.

.....  
.....  
.....  
.....

4. Describe a time when you can use stillness or camouflage.

.....  
.....  
.....  
.....

Name \_\_\_\_\_

Date \_\_\_\_\_

## MINDFUL MOVEMENT

**Select another animal. Practice walking and being still like this animal.**

Draw yourself walking like this animal in the space below.

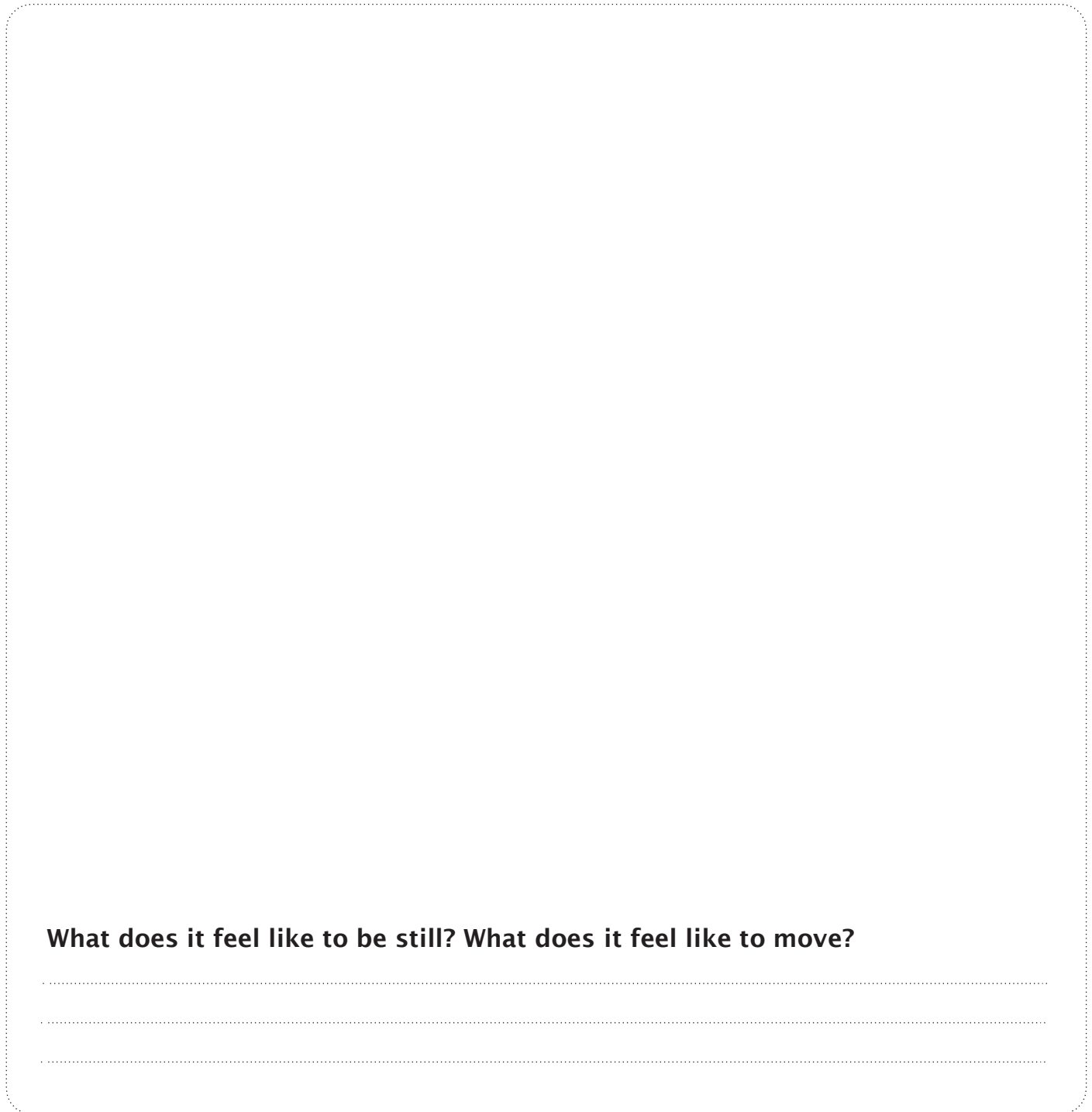

**What does it feel like to be still? What does it feel like to move?**

.....

.....

.....

Name \_\_\_\_\_

Date \_\_\_\_\_

# Seeing the Bright Side

We have a tendency to focus on the negative. Paying attention to positive things (and repeating them in your mind or out loud) can support more feelings of happiness and calm. It's like moving from a cloudy day to seeing the sun peek behind the clouds, and noticing the sunlight peeking through your window!

**Part 1:** Choose one person you would like to send a positivity note to today. Design a card or a short video that answers the following questions: What do you like about them? What do you wish for them (happiness, love, health)? Then send it to them to brighten their day!

**Part 2:** In the suns below, write down ten positive things that happened to you today or things that you love and enjoy (ex. playing outside with friends, watching a funny movie, a compliment that someone gave you, etc).

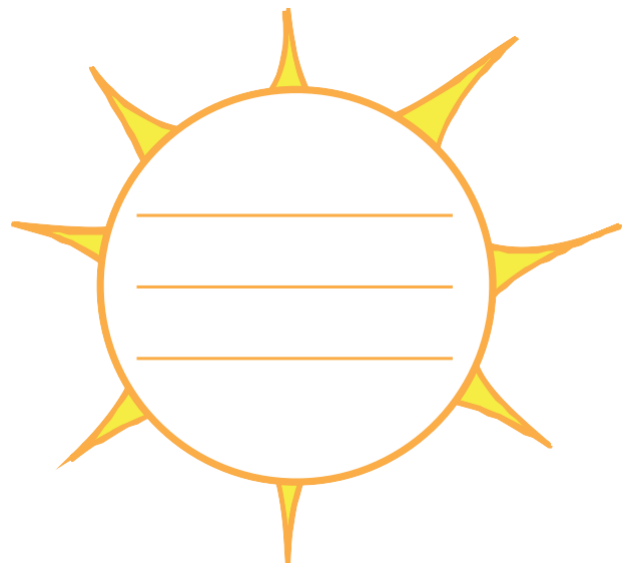
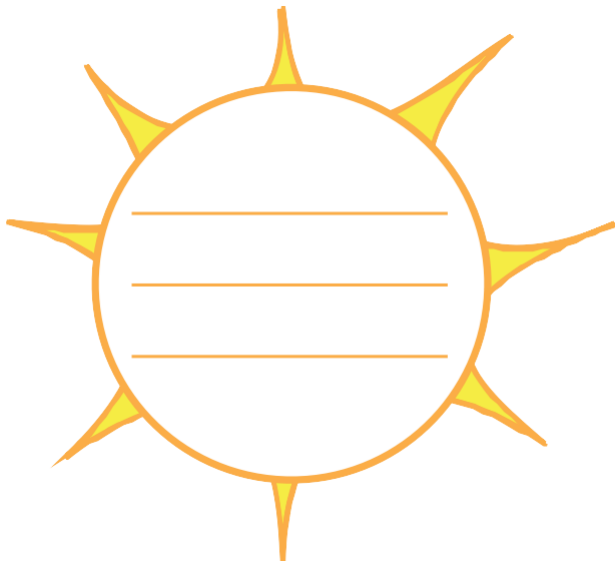
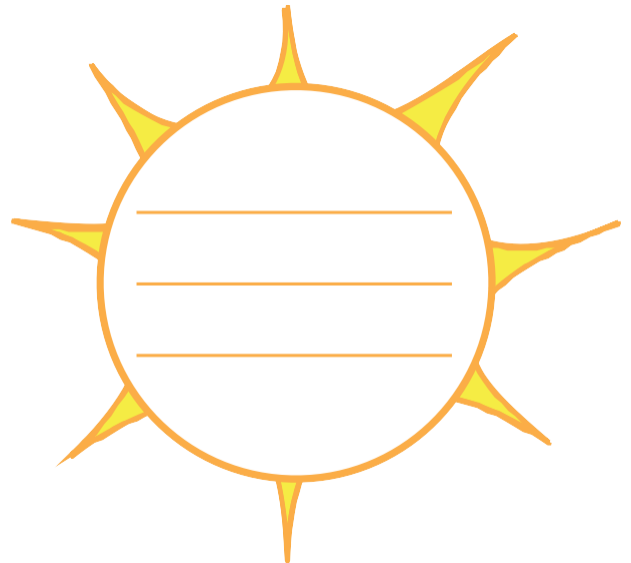
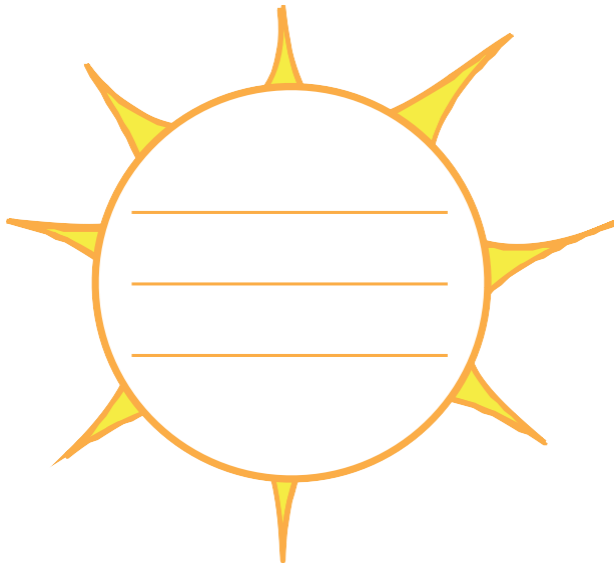

Name \_\_\_\_\_

Date \_\_\_\_\_

# Seeing the Bright Side

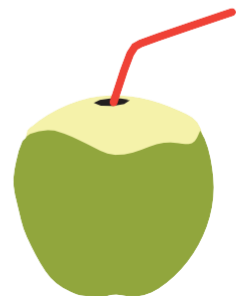
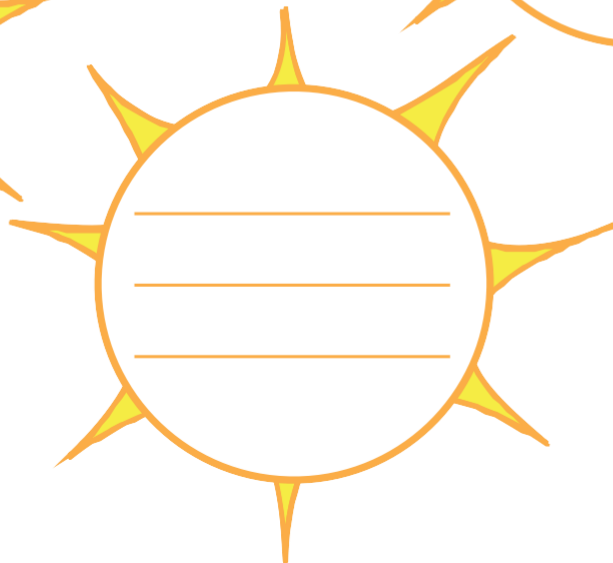
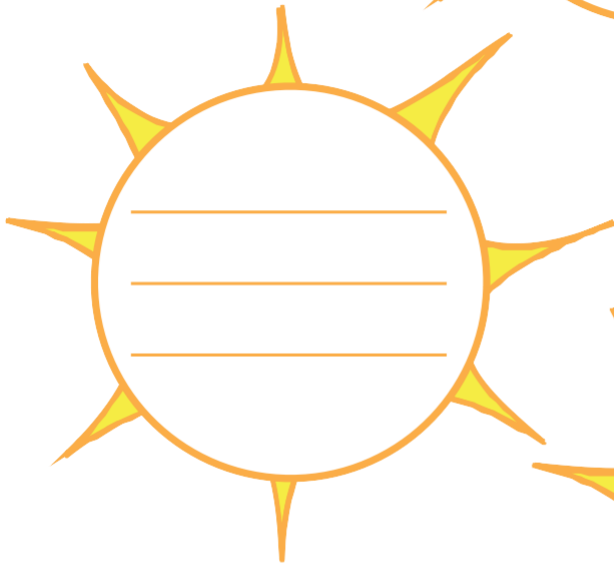
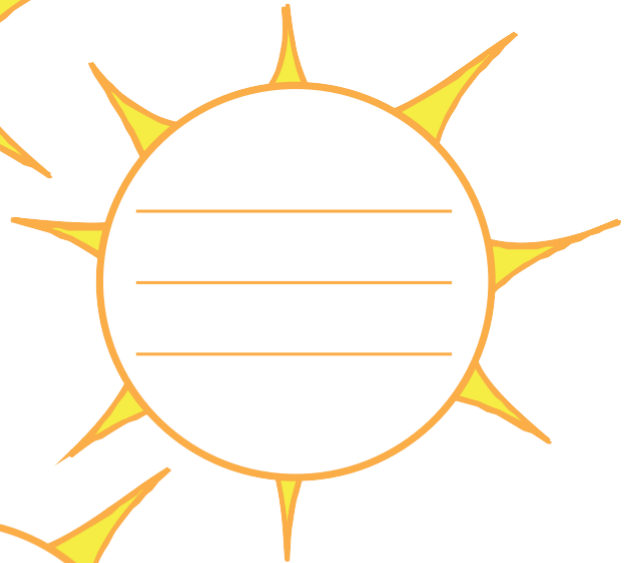
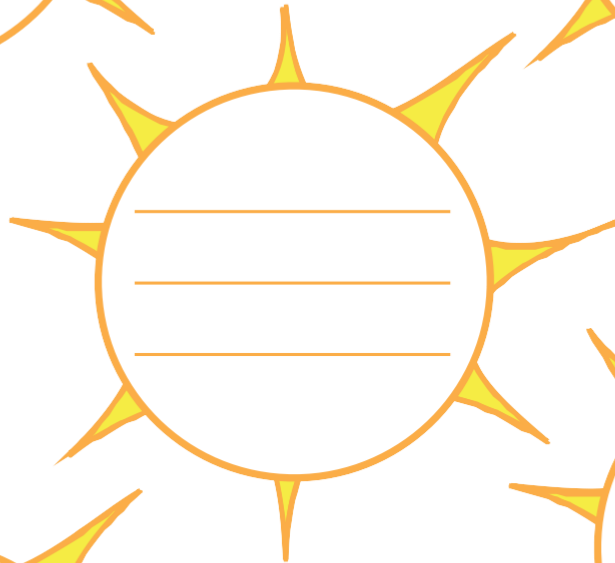
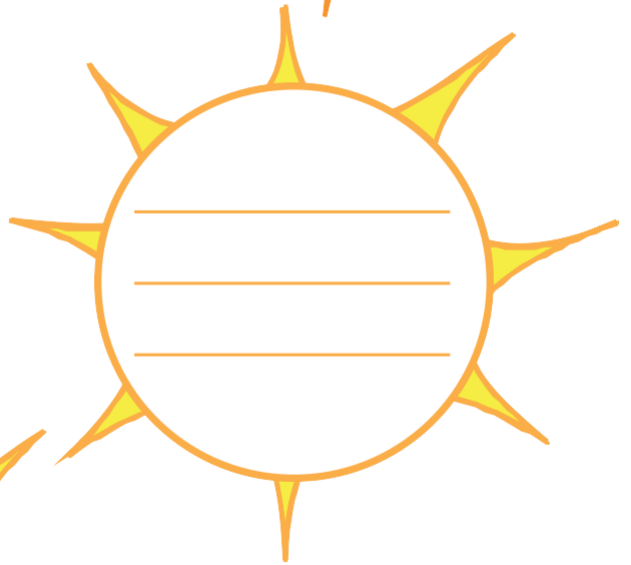
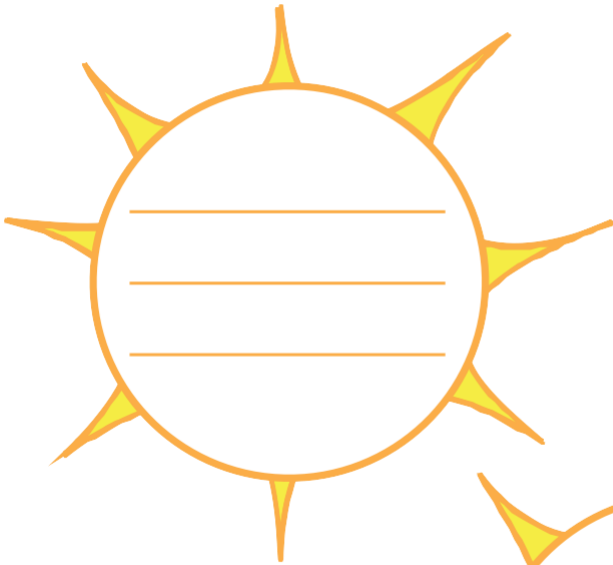

Name \_\_\_\_\_

Date \_\_\_\_\_



## Scavenger HUNT

# Find a NOUN

Pick a room inside or go outside. Write the nouns you find under the correct column. **Answers will vary.**



**Person**



**Place**



**Thing**

# Piggy's House Hunting: Find the Perimeter

Piggy needs to find a house with the largest perimeter.  
 Help Piggy by finding the perimeter of each house.  
 Then color the largest one.

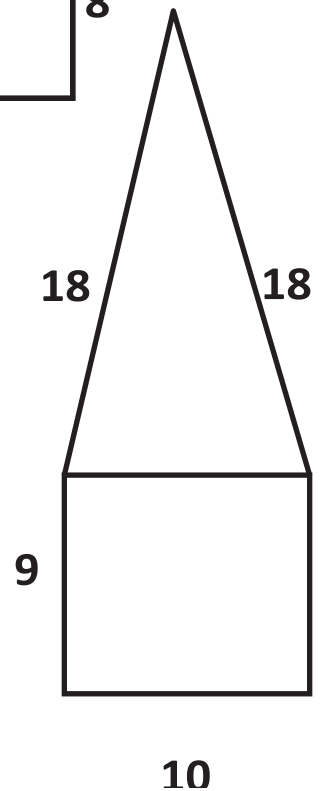
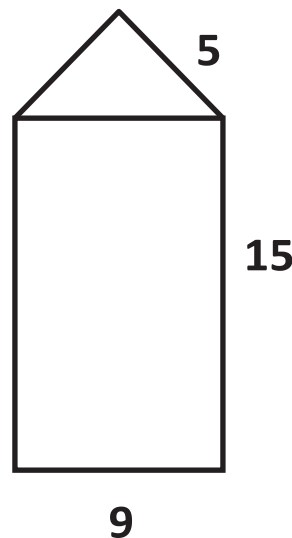
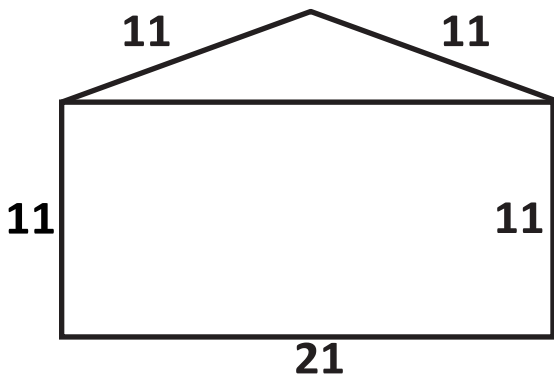
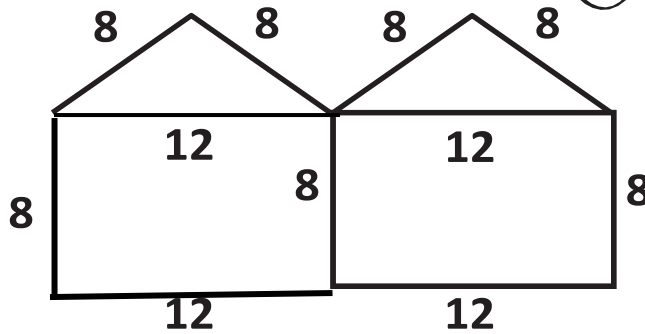
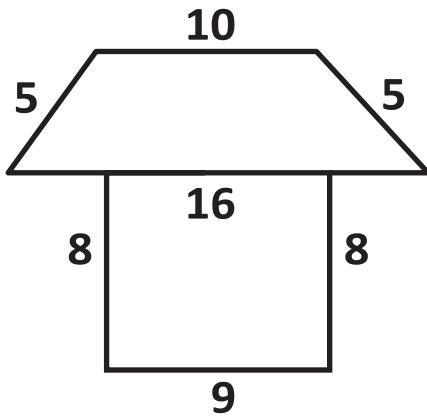
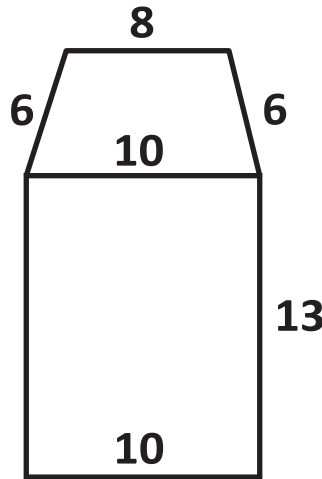
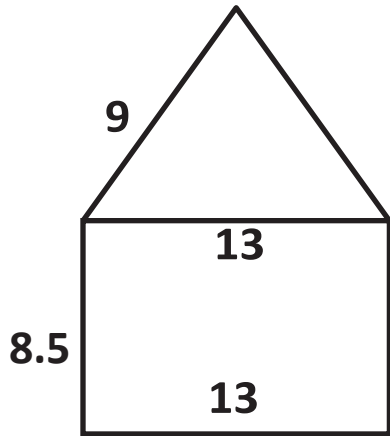
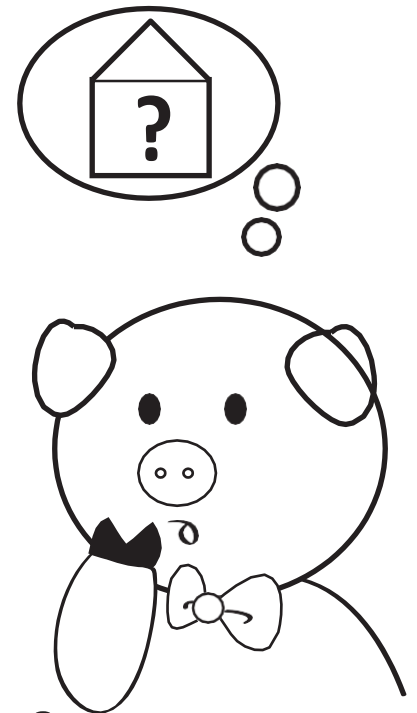



Name \_\_\_\_\_

Date \_\_\_\_\_

# I AM GRATEFUL (Answers will vary.)

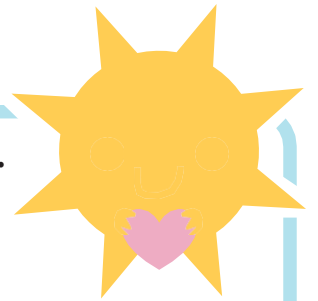

Gratitude helps us reflect on everything we have to be thankful for. Fill in the following prompts about what you are grateful for.

Nouns I'm Grateful for:

Verbs I'm Grateful for:

## Gratitude Web

Make a web to connect all that you are grateful for. Fill in things you are grateful for in the blank circles.

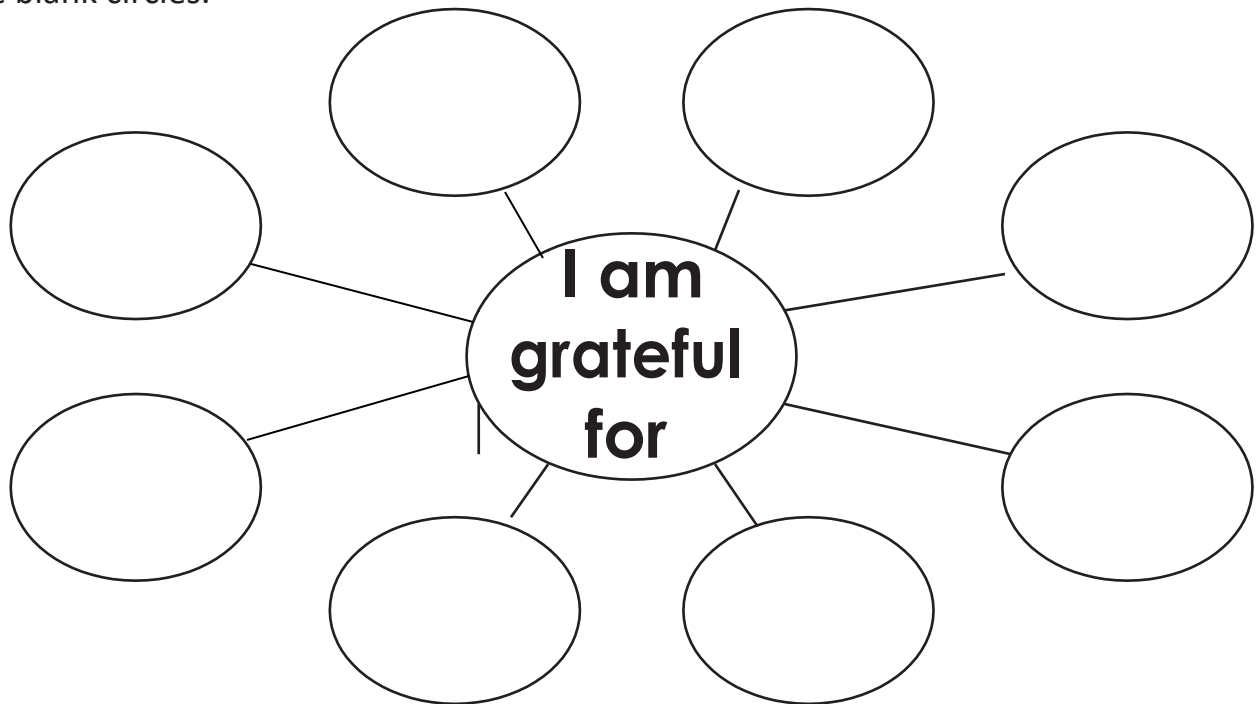

## Gratitude Buddy

It can be fun to be grateful together. Who can you practice gratitude with?

My gratitude buddy is \_\_\_\_\_.

Name \_\_\_\_\_

Date \_\_\_\_\_

# Gratitude Journal



Today I am thankful for \_\_\_\_\_

---

---

---

---

---

---

---

---

---

---

My kind act today was \_\_\_\_\_

---

---

---

---

---

---

---

---

---

---

Name: \_\_\_\_\_

Date: \_\_\_\_\_

## Fishing for Proper Nouns

**Proper Nouns** are nouns that name specific people, places, or things.

- Proper nouns are capitalized. Ex: Jacksonville
- If the proper noun has more than one word, capitalize only the important words. Ex: Statue of Liberty

**Directions:** Read the sentences below and circle all of the proper nouns.  
Then write them on the lines.

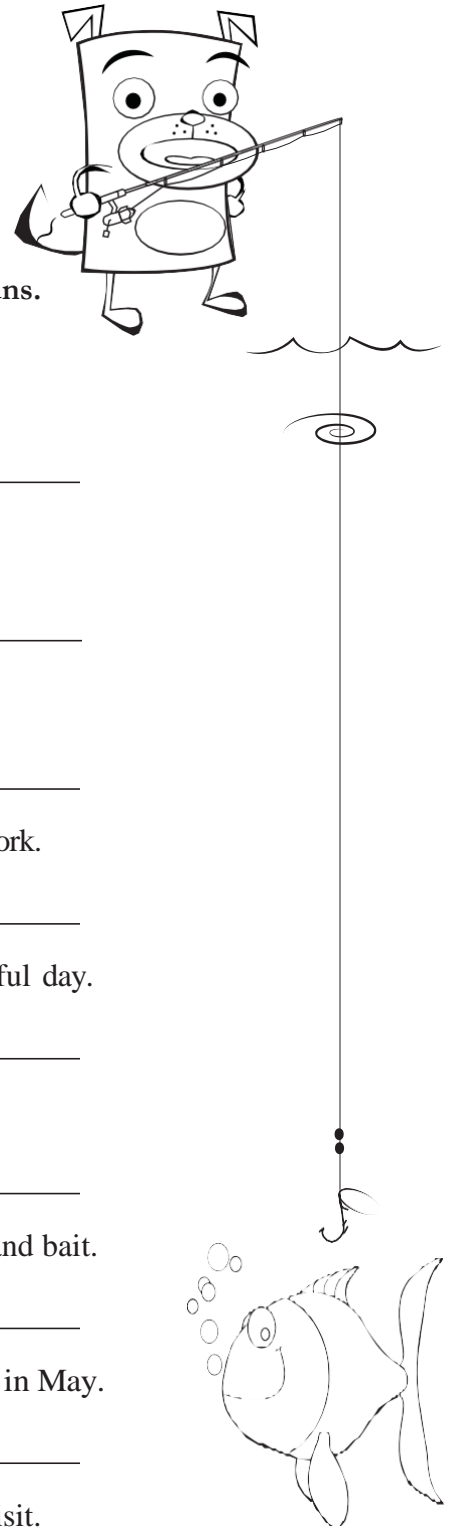

1. Jerrod enjoyed his visit to the Pacific Ocean over the summer.

\_\_\_\_\_

2. Jason and Jenny brought their fishing poles to the pond after school.

\_\_\_\_\_

3. The group took a boat called Shiny Star out on a Sunday.

\_\_\_\_\_

4. I caught some bass at the mouth of the St. Lawrence River in New York.

\_\_\_\_\_

5. There were many boats out on Clear Lake in California on the beautiful day.

\_\_\_\_\_

6. My father likes to take me to the Tennessee River on Labor Day.

\_\_\_\_\_

7. On Sunday, we went to Fishing Gear Company to buy fishing poles and bait.

\_\_\_\_\_

8. The small pond in the Farmingdale neighborhood was full of fish in May.

\_\_\_\_\_

9. Mr. Johnson told my class about the Great Lakes as a great spot to visit.

\_\_\_\_\_

10. He learned to fish when he was on a Boy Scouts trip in Idaho.

\_\_\_\_\_

# Sweet Estimation



Estimate the sum by rounding each number to the nearest hundred. Show your work!

$$\begin{array}{r} 189 \rightarrow 200 \\ + 334 \rightarrow + 300 \\ \hline 500 \end{array}$$

$$\begin{array}{r} 441 \rightarrow \\ + 323 \rightarrow + \end{array}$$

$$\begin{array}{r} 252 \rightarrow \\ + 368 \rightarrow + \end{array}$$

$$\begin{array}{r} 363 \rightarrow \\ + 429 \rightarrow + \end{array}$$

$$\begin{array}{r} 598 \rightarrow \\ + 176 \rightarrow + \end{array}$$

$$\begin{array}{r} 625 \rightarrow \\ + 238 \rightarrow + \end{array}$$

$$\begin{array}{r} \rightarrow \\ 324 \rightarrow \\ + 150 \rightarrow + \end{array}$$

$$\begin{array}{r} \rightarrow \\ 716 \rightarrow \\ + 202 \rightarrow + \end{array}$$

$$\begin{array}{r} \rightarrow \\ 137 \rightarrow \\ + 381 \rightarrow + \end{array}$$

$$\begin{array}{r} \rightarrow \\ 681 \rightarrow \\ + 99 \rightarrow + \end{array}$$

$$\begin{array}{r} \rightarrow \\ 528 \rightarrow \\ + 145 \rightarrow + \end{array}$$

$$\begin{array}{r} \rightarrow \\ 848 \rightarrow \\ + 136 \rightarrow + \end{array}$$

$$\begin{array}{r} \rightarrow \\ \rightarrow \\ 463 \rightarrow \\ + 276 \rightarrow + \end{array}$$

$$\begin{array}{r} \rightarrow \\ \rightarrow \\ 701 \rightarrow \\ + 163 \rightarrow + \end{array}$$

$$\begin{array}{r} \rightarrow \\ \rightarrow \\ 648 \rightarrow \\ + 220 \rightarrow + \end{array}$$

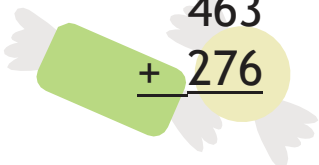

Name \_\_\_\_\_

Date \_\_\_\_\_

# Book or Character Mind Map



**Directions:** Look at this example of a book mind map. Then fill in your own mind map about a character or book you read.

## *The Wonderful Wizard of Oz*

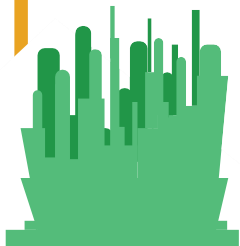
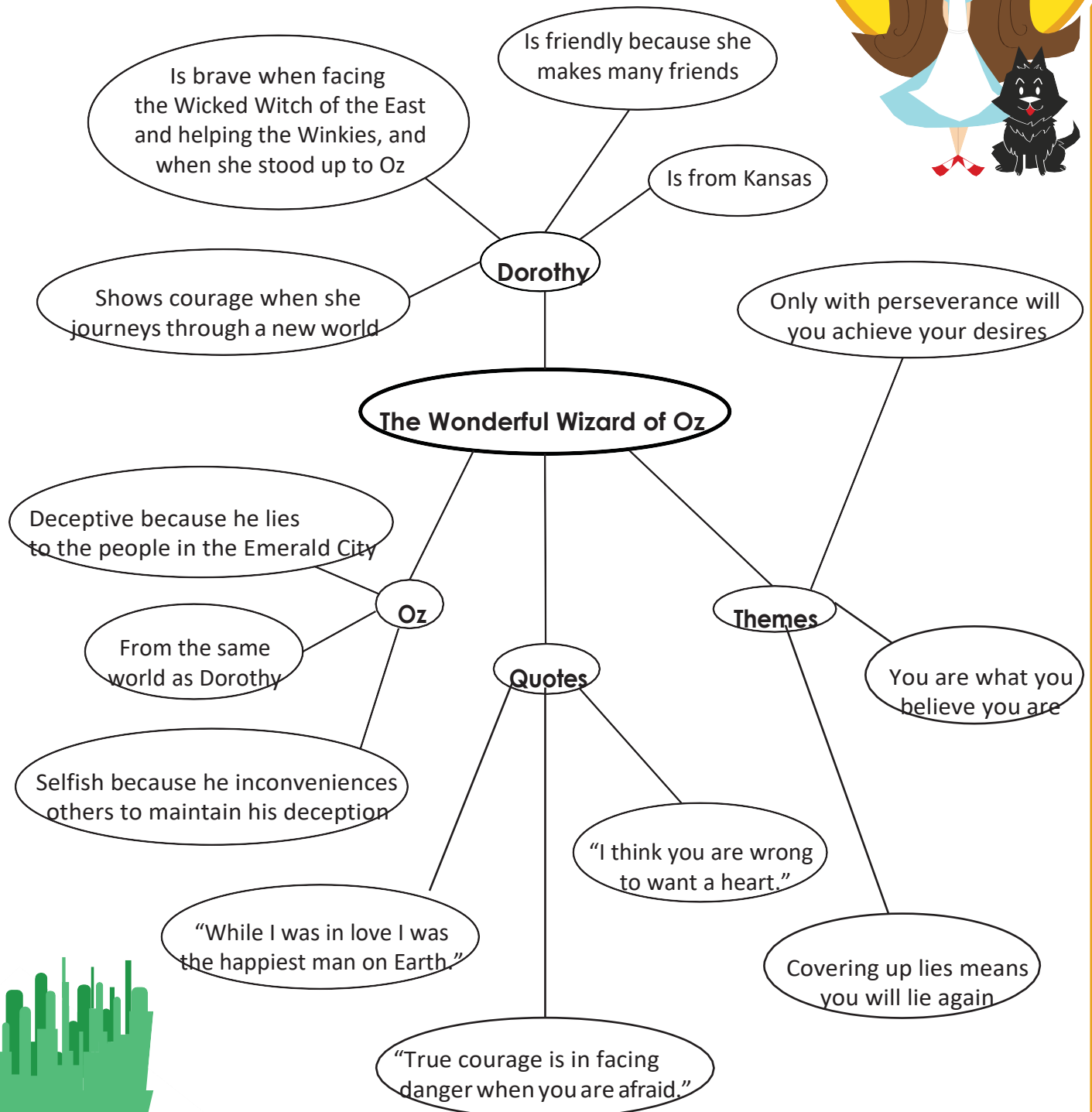

Name \_\_\_\_\_

Date \_\_\_\_\_

# Book or Character Mind Map

**Directions:** Create your own mind map. Write the book title or character name in the oval, then draw your own circles as you create your mind map using words or drawings. For example, you can write about conflicts, character traits, settings, or things you loved about the book or character. Answers will vary.

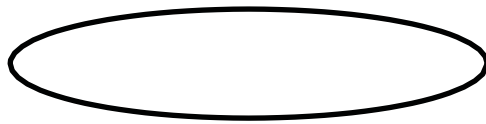

Name \_\_\_\_\_

Date \_\_\_\_\_

# Learning About Amelia Boynton Robinson

Amelia Boynton Robinson was born in Savannah, Georgia on August 18, 1911. Her mother helped African American women by assisting them in registering to vote. Amelia's mother would often take young Amelia along to help her. Her father was a skilled construction worker who also owned a wholesale wood lot. Amelia's parents encouraged their 10 children to work hard and do well in school. Amelia went to college at Tuskegee Institute in Alabama.



Amelia and her husband, Samuel William Boynton, worked together in rural areas to teach African Americans better ways to farm. They also helped people to register to vote and get an education. Voter registration forms were impossible to complete for those who were illiterate, or couldn't read. Amelia and her husband taught people how to fill out the forms so they could vote.

## Glossary of Key Terms

- **Vote:** when a person gets to choose a political candidate or an action/law
- **Civil rights movement:** an effort led by African Americans to end racial discrimination and gain equal rights
- **Discrimination:** when someone is treated unfairly based on their race, religion, or gender
- **Protest:** to say or show that you disagree with something

The Boyntons met Martin Luther King, Jr. in 1954 and got involved in the civil rights movement. They held meetings in their home for the movement. They organized marches and protests. In addition to her activism in the civil rights movement, Amelia Boynton Robinson ran for Congress in 1964 as the first African American woman candidate.

In March of 1965, Amelia helped organize a march from Selma to Montgomery to protest discrimination against African Americans. That day became known as Bloody Sunday because police beat the protesters during the march. Amelia was hurt by police officers when crossing the Edmund Pettus Bridge. The march helped to bring about the Voting Rights Act of 1965. This law makes it illegal to discriminate against African Americans when it comes to voting rights.

Amelia Boynton Robinson died in 2015 at the age of 104. She was an important civil rights activist who fought for equal rights throughout her life.

Name \_\_\_\_\_

Date \_\_\_\_\_

# Learning About Amelia Boynton Robinson

*Directions: Use the text to help you answer the questions below.*

1. Amelia Robinson was an important activist in the \_\_\_\_\_ movement.

2. Who did Amelia meet in 1954? \_\_\_\_\_.

3. How did Amelia help African Americans?

---

---

4. a) What event did she help organize in 1965?

---

---

b) Why was this event important?

---

---



Name \_\_\_\_\_

Date \_\_\_\_\_

# Letter to a Service Worker

**Directions:** Choose one service worker in your school or local community to send a thank you letter to (fireman/woman, lunch staff, nurse, etc.). Write a letter thanking them for their service. Then draw a picture for them on the back.

Who would you like to write a letter to? \_\_\_\_\_



Dear \_\_\_\_\_

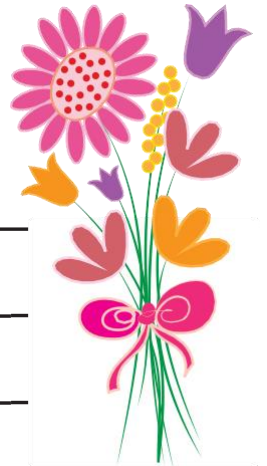

Sincerely,

\_\_\_\_\_

# Identifying Action Verbs

It is important to understand the difference between action verbs and the verb “to be” in writing. All action verbs show *action*. The verb “to be” is a *stative verb*, which means that it describes a state of being – **is, am, are, was, were**.

Circle the action verbs in each sentence.

Underline the “to be” verbs in each sentence.

1. My parents are hardworking people.
2. The horses waited patiently in the stable before the big race.
3. We were on the phone together for almost an hour.
4. The sun rises over those mountains every day.
5. We rushed to the bus stop, and my sister tripped on her shoelaces.
6. Tim and Mike always race to the lunch line for fun.
7. We were really scared during the storm.
8. The runner leaped over the last hurdle.
9. In our last soccer game I was the goalie.
10. My brother snores so loudly, especially during winter.

Name \_\_\_\_\_

Date \_\_\_\_\_

# COLOR BY NUMBER

Solve the following division problems. Color based on the answers matching to the color key.

SKY BLUE : 3 BROWN : 4 DARK GREEN : 5 GREEN : 6 RED : 7 YELLOW : 8 WHITE : 9

**(HINT:  $30/6$  is the same as  $30 \div 6$ )**

81/9      56/8      90/10  
30/6      18/2  
54/9      27/9      64/8      54/6  
25/5      9/3      42/6      45/5      36/4  
6/2      63/7      72/8  
35/5      72/9      9/1  
56/7      14/2  
24/3      63/9      3/1      72/8  
24/8      40/5      28/4      8/1      15/3  
36/6  
45/9      30/10      15/5      8/2  
12/4      36/12      30/5  
16/4      24/6      36/9      12/3      12/2  
66/11      18/3      12/3      42/7      24/4  
35/7      48/8      6/1      30/6      33/11      18/6      24/4  
35/7      48/8      6/1      30/6      33/11      18/6      40/8

Name \_\_\_\_\_

Date \_\_\_\_\_

# Storyboard



Draw pictures and write about what you draw in this graphic organizer.

---

---

---

---

---

---

---

---

---

---

---

---

---

---

---

---

---

---

---

---

---

---

---

---

---

---

---

---

---

---

---

---

---

---

---

---

Name \_\_\_\_\_

Date \_\_\_\_\_

# Empathy Scenarios

**Read about each scenario and think about how you would relate. Answers will vary.**

## Scenario #1

Mr. Pratt gave reading quizzes back during class. Matt said, "Wow, this is great! I studied all week for this quiz, I am so glad I did well!" Carter said, "Matt, quit bragging! Just because you got a good grade doesn't mean you have to tell everybody!"

How would you feel if you did well on a quiz you studied all week for?

## Scenario #2

Barry threw a piece of food to try to get it into the wastebasket during lunch. Mrs. Williams, the cafeteria worker, saw the food in the corner of her eye and thought it was Susan who threw it. Mrs. Williams made Susan clean up the food and kept her inside during recess. During P.E., Barry said, "I am sorry you had to stay in for recess, Susan." Susan said, "I can't believe you did not tell her that you did it! I don't want to talk to you ever again!" Barry said, "You don't have to yell! What's wrong with you?"

How would you feel if you got in trouble for something you did not do?

## Scenario #3

Kaila is brand new to school and is sitting with girls during lunch. Mya asks Kaila, "How are you?" Kaila says, "Good." Mya asks, "What do you like to do for fun?" Kaila says, "Read." Mya asks, "What are you doing over the holiday?" Kaila says, "I'm not sure." Mya rolled her eyes and said, "Are you always this boring?"

How would you feel if you were new to school and did not know anyone?

## Scenario #4

Sandy was given a horse from her parents for her birthday. She had always loved to ride and wanted a horse of her own. "Hey, Sandy" Kelly said. "What did you get for your birthday?" "A horse, my very own horse that I can ride every day!" Sandy squealed as she jumped around. "What has gotten into you?" Kelly asked. Sandy said, "Nothing!" But she kept jumping. Kelly walked away. "What are you doing?" Sandy asked between jumps. "I'd rather talk to you when you stop being weird," Kelly replied.

How would you feel if you were given a gift you'd always wanted?

# My "Best Self" Timeline

**Directions:**

1. Reflect over the past week on all of the ways you showed up as your "best self."
2. In the timeline below, write down each moment.

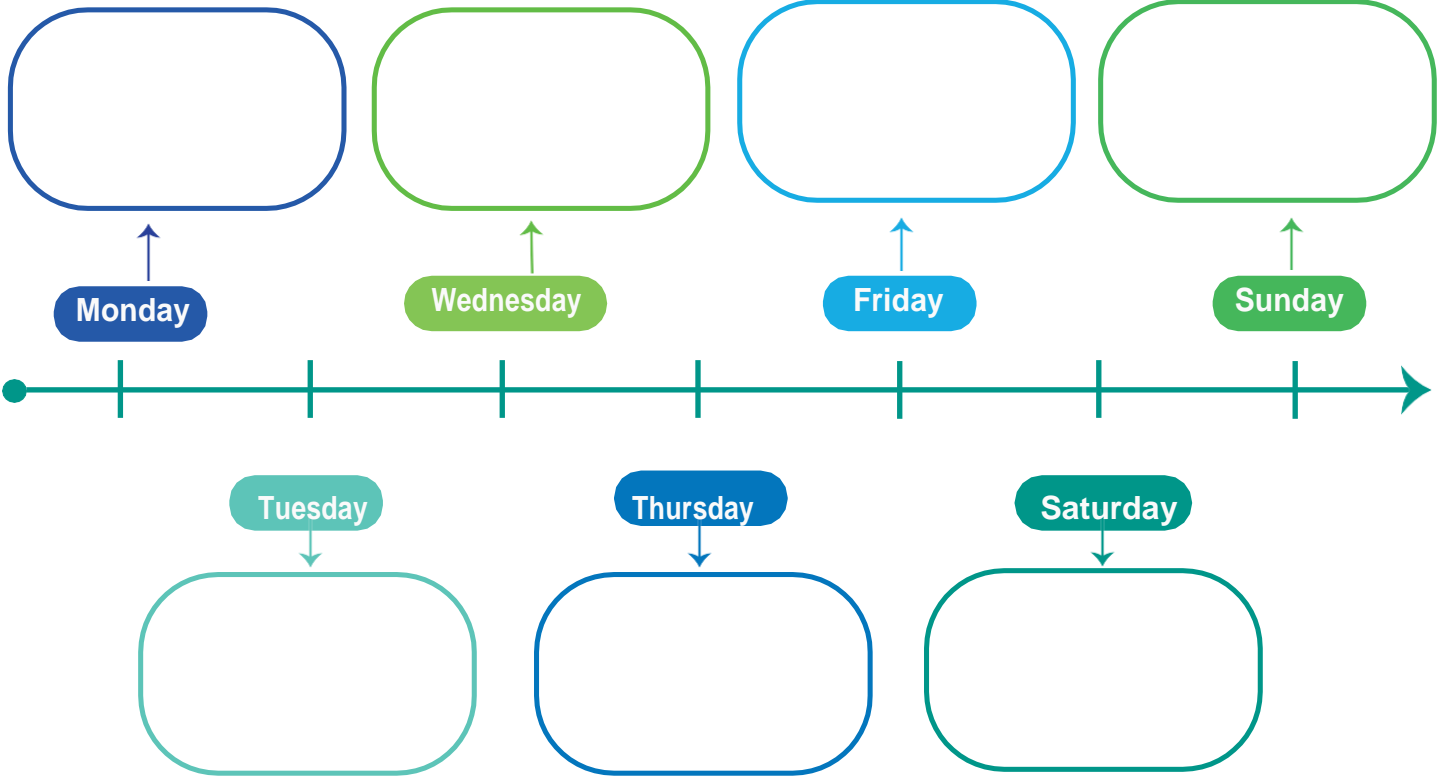

3. Draw a picture of a moment this past week where you were your best self.



# Adverb Detectives: Again!

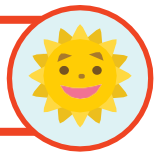

Name: \_\_\_\_\_

Date: \_\_\_\_\_



## The Descriptive Detectives: Again!

The Descriptive Detectives view a mystery as a story with the key-words and details missing. **Adverbs** are words that provide more information about verbs: how something is done or when it occurred.

**Example:** The salesperson of the town hybrid auto dealership, Ms. Greenlease, **exquisitely** displays luxury automobiles in her showroom. Ms. Greenlease **kindly** greets customers when they come in, except when she is **completely** involved in a phone conversation while drinking coffee.

*A hybrid SUV is missing from Ms. Greenlease's dealership! Below are adverbs and sentences from the detectives' descriptive report written after closely investigating the scene of the crime and interviewing Miss Greenlease. Match the appropriate adverb with the verb it would be best suited to describe.*

1. promptly

2. excitedly

3. intentionally

4. longingly

5. quietly

6. loosely

7. hurriedly

8. slowly

9. discreetly

10. sadly

Ms. Greenlease noted that she \_\_\_\_\_ opened the auto dealership at 8:00 a.m.. \_\_\_\_\_, she parked the new 500 horsepower golden hybrid in the display window at the front of the store. Her cell phone then \_\_\_\_\_ vibrated within her pocket. Ms. Greenlease shared that she \_\_\_\_\_ answered it since it was her sister, who she was anxious to tell about the latests flagship hybrid high-performance models. As she was talking on the phone, she \_\_\_\_\_ put the keys for the new vehicle next to the \_\_\_\_\_ opened envelope that contained packaging material for the smartkey. Ms. Greenlease said she \_\_\_\_\_ stuffed the envelope into the lower left drawer of her desk. She then \_\_\_\_\_ described the new fleet of vehicles expected to arrive later that day, savoring all the details while finishing her coffee. She recalls \_\_\_\_\_ staring at the photograph of a fire-engine red coupe on her desk. At 9:00 a.m. she \_\_\_\_\_ strode back into the showroom to find there was no fresh coffee prepared and noticed that the new 500 horsepower golden hybrid smartkey was no longer on her desk! What did the Detectives deduce might have also been stuffed in the lower drawer of Ms. Greenlease's desk?

## Comparing Two Nonfiction Texts: We Need Clean Water

**Directions:** Using two informational texts on the same topic, complete the graphic organizer.

### Text 1:

Do you drink enough water each day? Our bodies need water to survive. Our bodies are mostly made up of water. We need to replenish, or replace, water each day. The human body uses water in many ways.

Water keeps the body's temperature normal. It helps move waste through the body. It helps keep our joints, like our elbows, knees, and shoulders, moving smoothly. Every cell in our body needs water so it can keep working properly.

We are hydrated when we drink enough water. If we don't drink enough water, our bodies become dehydrated. When this happens, our bodies stop working properly.

Water helps our bodies in other ways, too. It helps with headaches, and it helps us feel more energized. Also, it helps us to not overeat. Sometimes we think that we are hungry, but we are really just thirsty. When we drink enough water, it helps us to maintain, or keep, a healthy weight. Water is also helpful with bad breath and bad moods.

There are many important benefits of water. Our bodies need clean water to survive, so it is our job to drink enough each day.

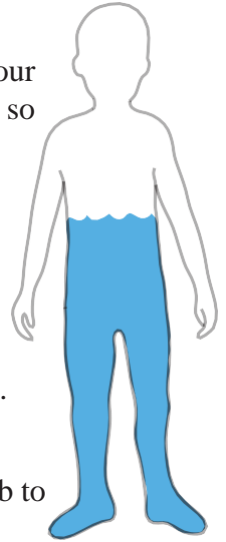

### Text 2:

Contaminated water is unclean water. It is not safe to drink. It has toxins, or dangerous poison, in it. Did you know that there is water all over the world that is contaminated? People drink this poisonous water because they do not know that it is contaminated.

In 2014, the town of Flint, Michigan, changed their water source. They used to get water from Lake Huron. It was changed to the Flint River in 2014. They did this to save money.

However, people in Flint said that the water smelled and tasted funny. They also said it looked funny. The city investigated and realized that the water was not completely clean. They tried to fix it by adding chlorine to the water. They also flushed the pipes. At times, they told the residents, or people living there, to boil the water before drinking it. After that, they said it was safe to drink.

This continued into 2015. The city investigated and warned the people that the water might have some problems. There were toxins in the water that cause cancer. Children began getting sick with rashes and strange illnesses. Parents and other residents were concerned and tried to talk to the government about the problem.

Researchers found that the water had lead in it. Lead is found in pipes and other fixtures in older homes. Lead is a toxic metal that is harmful to health. It is especially harmful to children. Humans should not have any exposure to lead at all.

It took over a year for the government to take this water problem seriously. In 2016, the National Guard brought bottled water to the people of Flint. It was too unsafe for them to drink water out of the faucet.

Many of the people from Flint, Michigan, are dealing with illnesses from the bad drinking water in their city. They are asking the government to help them.

Safe, clean drinking water is important for human beings. Our bodies need water to survive and to be healthy. Water keeps every part of our bodies working properly, and it must be safe water with no toxins.





Name: \_\_\_\_\_

Date: \_\_\_\_\_

## Comparing Two Nonfiction Texts: We Need Clean Water

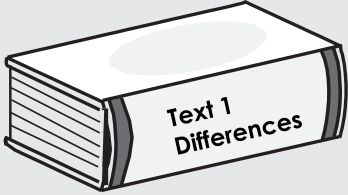
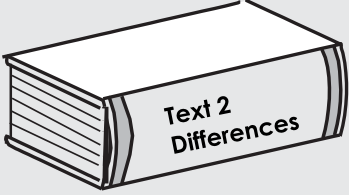
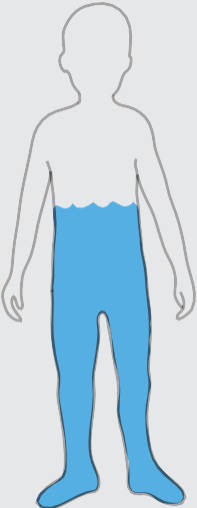
		<b>Similarities</b>	
<b>Topic</b> What topic is being explored in these two texts? How are the topics different?			
<b>Main Idea</b> What is the main idea or main focus of each of the texts?			
<b>Supporting Details</b> List at least two details that the texts have in common. List at least two details that are different in the texts.			
<b>Written Response:</b> Which text would be better to find information about why drinking water is a healthy choice? 	<hr/> <hr/> <hr/> <hr/> <hr/> <hr/> <hr/> <hr/> <hr/> <hr/>		

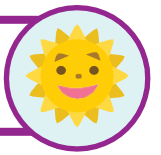

Name: \_\_\_\_\_

Date: \_\_\_\_\_

Read the short story. Then come up with compliments, suggestions, and corrections to help improve the story.

It was late at night and everyone had gone to bed ours ago. I was dreaming peacefully, when suddenly I woke up to a loud clattering sound coming from the kitchen. I rubed my eyes and nervously called out whose there? I waited, but the house was silent. "Hello?" I called out, a little louder. Still no one ansered. I cautiously climbed out of bed and grabbed my flashlight. Slowly, I tiptowed out of my room, toward the kitchen. As I got closer, I heard a low growling sound coming from a dark corner quickly, I turned on my flashlight and pointed it like a sword, expecting to see a monster. The brite light lit up the Kitchen and I let out a yelp. There, in the corner, was my cat, Noodles! She was sur rounded by pots and pans and in her pause, she held a tiny, shaking mouse. "Noodles!" I scold, "Look at this mess youve made!" I hurriedly shooed the frightened mouse out of the house before picking up all the pots and pans that had been nocked down. When I finally returned to bed, Noodles was asleep on my pillow, purring contentedly.

1. Write three **compliments** for the author of this story.

---



---



---

2. Write three specific **suggestions** to improve the story.

---



---



---

3. Use editing marks to **correct** the spelling, grammar, punctuation, and capital letters in the story.

### Editing Marks

Capitalize letter ≡

Add a period ●

Add a question mark (?)

Add a word or comma ^

Take words or letters out ✂

Correct spelling ○

Lowercase letter \_

Indent ¶

# WORD PROBLEM SUBTRACTION

Read each story problem. Write a number sentence and solve each problem.

1. To raise money for a new science lab, Martinez Elementary is selling T-shirts and hats with the school's name on it. They sell 73 T-shirts and 29 hats. How many more T-shirts did they sell than hats?



\_\_\_\_\_

2. Mrs. Cosgrove, who teaches gym, needs to order uniforms for her students. She has received 24 order forms from girls and 19 order forms from boys. How many more girls than boys does she teach?

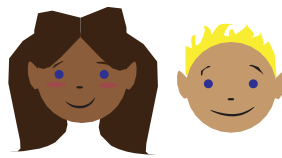

\_\_\_\_\_

3. Martinez's school play is this weekend, and they've sold 229 tickets so far. Last year, they sold 177 tickets. How many more did they sell this year?



\_\_\_\_\_

4. The kitchen staff has 66 containers of skim milk and 41 containers of chocolate milk chilling in the fridge. If they expect 100 students to order skim milk, how many more cartons of skim milk do they need?



\_\_\_\_\_

5. There are a total of 904 students at Martinez Elementary. 426 of them live in Schoonerville. The other students live in Archer City. How many students live in Archer City?



\_\_\_\_\_

6. 2nd grade is holding a bake sale. Mrs. Yang's class has sold 50 cupcakes and 24 cookies, while Mr. Argent's class has sold 37 brownies and 19 slices of cake. How many more items has Mrs. Yang's class sold?



\_\_\_\_\_

# Walking the World

Has your child ever wished to travel the world and meet new people? Why not keep track of his future travel plans with a foot craft that will help him show off all the different places he'd like to visit someday. Not only will he learn about different continental locations, but he may be surprised by the international variations and connections of the people he hopes to meet during his travels.

## What You Need:

- Paper
- Hard surface
- Pencil
- Feet
- Crayons or colored pencils
- Pen

## What You Do:

1. Hand your child a piece of paper and a pencil.
2. Place the paper down onto a hard surface and have your child place a single foot on the paper.
3. With a pencil, help him trace out each of his toes carefully.
4. Once complete, have your child set his other foot right next to the traced outline of his first foot.
5. Repeat step three to create an outline of his two feet side by side.
6. Now, pull out some colored pencils and a pen.
7. With the pen, have your child add in a smiling face to each toe of his outlined feet.
8. Once done, let your child decide which country he wants each of the toes to represent. If he needs help deciding, feel free to help him look up people of different cultures from all over the world in a book or on the Internet.
9. As soon as he has decided which country he wants each toe to represent, help him look up examples of the types of clothes the people from those countries wear.
10. Using the crayons or colored pencils, have your child add clothes and hair to each toe accordingly.
11. Encourage him to add details and finish coloring in his toes from around the world.
12. If there's room, have your child add hands to each toe so that the people from each country represented can hold hands. This is a great way to teaching your child the importance of embracing cultural differences.

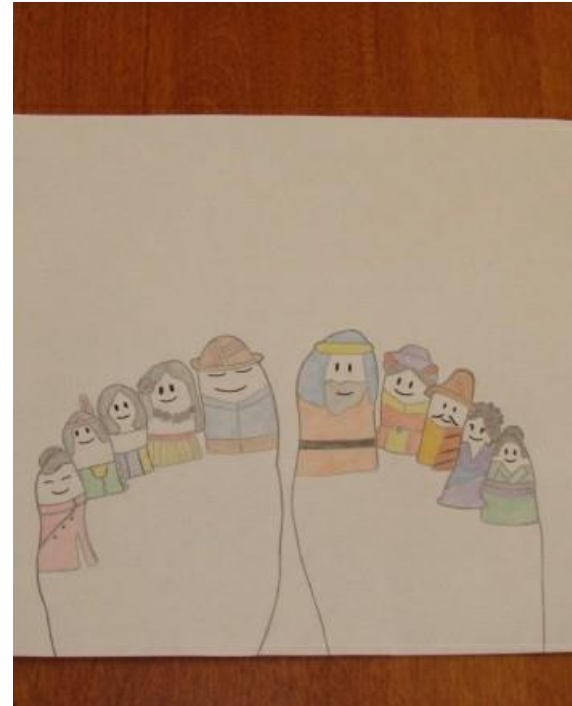

# Science

DIY Pinwheels

Superhero Strength



# DIY Pinwheels

Your child can transform a piece of construction paper into a fun toy to use in the sunny outdoors! The pinwheel is a simple toy that has been around years and years, which harnesses the wonders of the wind to delight kids of all ages!

## What You Need:

- Construction paper
- Scissors
- Ruler
- Pencil
- Stickpin

## What You Do:

1. Encourage your child to do some research online before creating her pinwheel. She can see if she can discover anything interesting about the history of pinwheels and interesting designs and constructions.
2. Invite your child to use the ruler to measure a 6" x 6" inch square. She can use scissors to cut out her square for making the pinwheel.
3. Now she can use the ruler to draw an X from corner to corner on the square dividing it into four triangles.
4. Offer her the scissors and have her cut from each corner along the line until she just about reaches the center of the square – but not cutting all the way through! When she's finished, she'll have four cuts moving diagonally towards the middle.
5. To create her pinwheel, invite your child to begin folding in one corner of each "triangle" to the middle of the square. She can hold the pieces together and then secure them by pushing a stickpin through the middle.
6. Now she can secure the pinwheel to the eraser of a pencil and take her finished pinwheel outside to enjoy!



# Superhero Strength

Teach your child the tricks of their favorite super-strong superhero! Then, get ready for them to show off their great strength while learning about the difference between horizontal and vertical forces. They'll also gain a better understanding of how balance works. This is a great trick they can share with friends!

## What You Need:

- Adult volunteer (the stronger, the better!)

## What You Do:

1. Ask the adult helper to stack one fist on top of the other and extend their arms until their elbows are straight. Feel free to have them growl, or make noises indicating how strong they are!
2. Have your child place two fingers on the top fist, and two on the bottom fist. When they're ready, have them quickly push the fists in the opposing directions.
3. They'll notice how easy it was to separate the strong fists, and may not believe they could possibly be that strong. Have them try it one more time so as to confirm their power.
4. This time, have the adult volunteer, push their fists together even more fervently than before and have your child repeat the experiment.
5. This was even easier! Why?

Explain to them that when the fists are stacked, pushing together, it creates a vertical force. Vertical forces can only push up and down, not side to side. So, when they pushed side to side with their super strength, (or horizontal force), they disabled the balance of the vertical force, making it impossible for the adult to keep their fists stacked.



# Optional

## Design Challenge

Marble Labyrinths





# Design Challenge: Marble Labyrinths

In this activity your child will create a marble maze out of large straws and other materials. This challenge allows for open exploration time with the materials and then provides challenges for your child to complete based on how they respond to being able to first create a maze without restrictions. This activity gives your child room to try a challenge multiple times and many different ways, and gives your child the opportunity to solve a problem creatively.



## What You Need

- 1-2 marbles
- Large milkshake straws
- Any other recycled materials that your child would like to use in their maze
  - Bottle caps
  - Popsicle sticks
  - Cardboard
  - Construction paper
  - Paper towel rolls
- Box lid (a shoebox works well; collect a few of these to make multiple mazes)
- Scissors
- Tape or glue
- Pen and paper for brainstorming and notetaking

## What You Do

1. To begin, talk to your child about what makes a maze fun or challenging and how they can create their own. Ask your child if they have played games with mazes or seen mazes before.
  - a. What made the mazes difficult or easy?
  - b. What made the mazes fun?
  - c. Did the mazes use one kind of material or shape or multiple kinds of materials or shapes?
2. After discussing with your child, show them all of the items they will use to create their mazes and allow them to explore the materials.
  - a. Ask your child to create a maze for a marble to go through. If your child needs help cutting more straws, assist them with this step. However, try to let your child play with creating different mazes on their own.
  - b. Remind your child that they can use any of the materials available to make their maze.
3. Once your child has had sufficient time to make a first maze, have your child test it. Instruct your child to place a marble at their maze's entrance and have them solve their maze. Ask your child what they noticed while making and solving their maze.
  - a. What made the maze easy or difficult to solve?
  - b. How did the marbles interact with the different materials?
  - c. How long did solving the maze take?
  - d. What were the steps used in designing their first maze?
  - e. How could using the design process help create more complex or well thought out mazes?
4. Now, introduce the design challenge to your child. Tell them that they will use what they've already learned by making their first maze to solve different maze challenges. Give your child a challenge to start. Challenges could include:
  - a. Make a maze using three different kinds of materials.

- b. Make a maze using only four straws.
  - c. Make a maze that looks like a smiley face, heart, or other shape.
  - d. Make a maze that uses only straws or another type of material.
  - e. Make a maze that takes a friend or family member over 30 seconds to solve.
  - f. Make a maze in under 1 minute.
  - g. Use every material on the table to make a maze.
  - h. Make a maze that has pieces cut out of the base box lid, which make the maze more difficult to solve. (You might have to assist your child with cutting the lid).
  - i. Make a maze with no sides to keep the marble inside of the maze. (You might have to assist your child with cutting cardboard or their box lid).
5. Ask your child to brainstorm different ways to create a maze for one of the challenges. Have your child draw or write their ideas on a piece of paper. Your child could also lay pieces in their maze box without taping or gluing anything down.
6. After your child has several ideas, ask them to choose the design that they think will work best. Remind your child of the goal of the maze: to complete the challenge assigned to them.
  - This is an important step of the design thinking process, because it teaches your child to prioritize the functionality of their prototype (design) over their personal preferences. This also prevents them from getting too emotionally attached to one design.
7. Now, it's time for your child to build their maze! Give your child space to experiment, but step in to help if necessary. Allow your child's ideas to evolve as they try out different ways of making their maze and encourage your child to write down what works and what doesn't work.
8. After your child has finished their maze, have them test it.
  - a. If your child's maze has successfully completed the challenge, congratulate them on their work!
  - b. If your child's maze does not complete the challenge, ask them what they think went wrong. Discuss what worked and didn't work in the building process and ask your child to go back to the brainstorming stage and try out a different design.
9. Once your child has successfully completed a challenge, give them another one to complete or allow them to make up their own challenges, restrictions, and requirements for their mazes.